

Mechanism Differences

The Standard Mechanism

- Designed for guest use.
- Manual, flip down leg holds mattress in place.
- Uses up to a 9" mattress.
- Standard size from single to queen.
- Mattress sits on the back of the back panels.
- Have to remove some bedding before closing,
- 5 year warranty.



Deluxe Easy-Lift Mechanism Studio 2000

- Designed for frequent use
- No Legs, bed rests on the crown moulding
- Uses up to a 9" mattress.
- Standard size from single to king.
- Mattress sits on a European slat system.
- Moving headboard allows bedding to stay in place.
- Counterbalanced, tension-adjustable mechanism,
- Has a drop down table option.
- 30 year warranty



Deluxe Easy-Lift Mechanism Auto Leg

- Designed for frequent use
- Automatic leg that folds up & down with the bed
- Bed sits at a standard bed height
- Uses up to a 9" mattress.
- Standard size from single to king.
- Mattress sits on a European slat system.
- Moving headboard allows bedding to stay in place.
- Counterbalanced, tension-adjustable mechanism.
- Has a drop down table option.
- 30 year warranty



Instant Bedrooms

Manufacturing Inc.

WALLBED MEASUREMENTS

DELUXE UPRIGHT



STUDIO 2000 AND AUTO LEG								
	WIDTH		HEIGHT		DEPTH		PROJECTION	
Bed Size	inches	cm	inches	cm	inches	cm	inches	cm
SINGLE	44	112	80	204	21	54	91	232
DOUBLE	59	150	80	204	21	54	91	232
QUEEN	65	165	85	216	21	54	96	244
KING	82	209	85	216	21	54	96	244



STANDARD UPRIGHT

	WIDTH		HEIGHT		DEPTH		PROJECTION	
Bed Size	inches	cm	inches	cm	inches	cm	inches	cm
SINGLE	44 1/2	114	80	204	16	41	86	219
DOUBLE	59 1/2	152	80	204	16	41	86	219
QUEEN	65 1/2	167	85	216	16	41	91	232
KING	N/A	N/A	N/A	N/A	N/A	N/A	N/A	N/A

DELUXE SIDE-FOLD

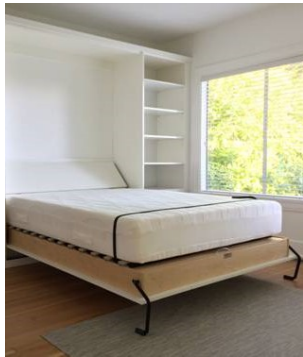

STUDIO 2000 AND AUTO LEG								
	WIDTH		HEIGHT		DEPTH		PROJECTION	
Bed Size	inches	cm	inches	cm	inches	cm	inches	cm
SINGLE	80	204	44	112	21	54	55	140
DOUBLE	80	204	59	150	21	54	70	178
QUEEN	85	216	65	165	21	54	76	194
KING	N/A	N/A	N/A	N/A	N/A	N/A	N/A	N/A



STANDARD SIDE-FOLD

	WIDTH		HEIGHT		DEPTH		PROJECTION	
Bed Size	inches	cm	inches	cm	inches	cm	inches	cm
SINGLE	80	204	44	112	16	41	50	127
DOUBLE	80	204	59	150	16	41	65	165
QUEEN	85	216	65	165	16	41	71	181
KING	N/A	N/A	N/A	N/A	N/A	N/A	N/A	N/A

WALLBED FRONT OPTIONS

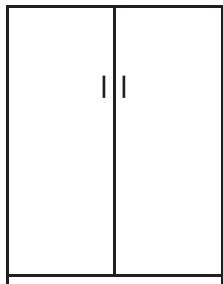

1

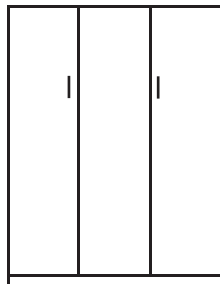

2

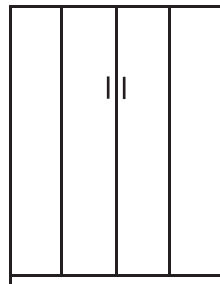

3

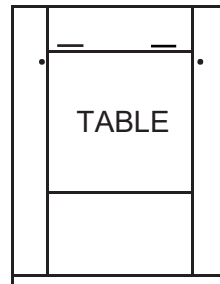

4

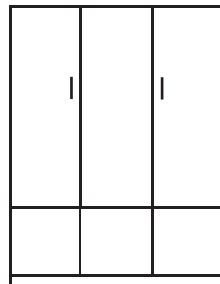

5

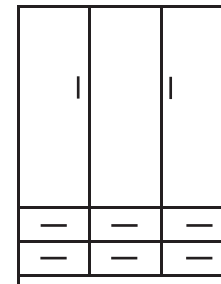

6

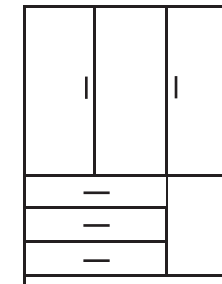

7

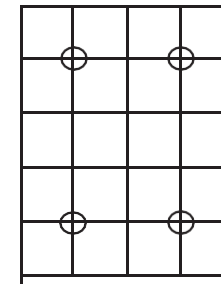

8

#102 - 12925 115th Avenue
Surrey B.C Canada V3R 0E2
Phone: 604.588.7485

wallbeds.com
info@wallbeds.com
Phone: 604 669 2337

125 - 1080 Mainland Street
Vancouver B.C. Canada V6B 2T4
Phone: 604 669 2337 Fax: 604 685 2337

Instant Bedrooms

Manufacturing Inc.

CABINET STYLES

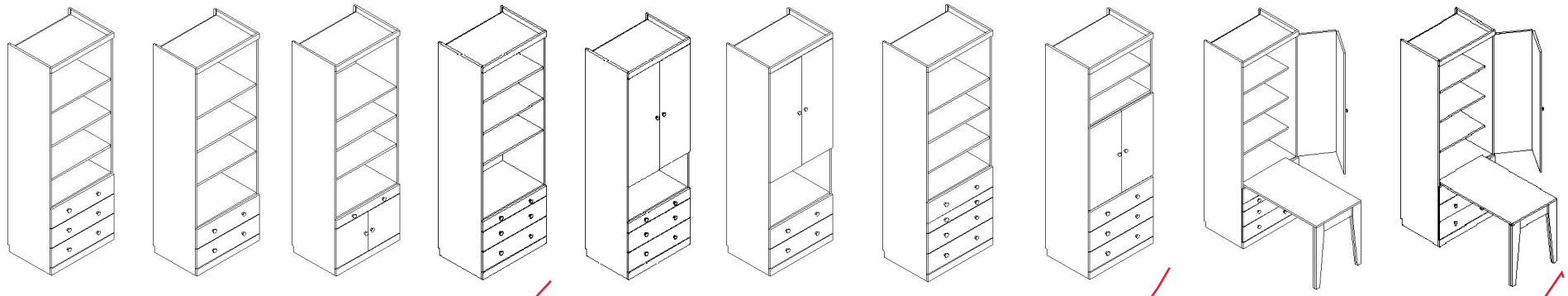

A

B

C

D

E

F

G

H

I

J

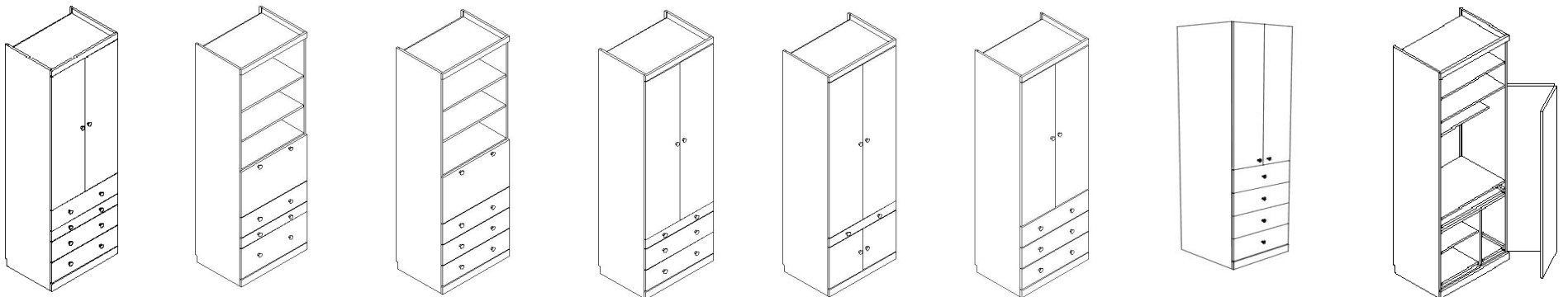

K

L

M

N

O

P

Q

R

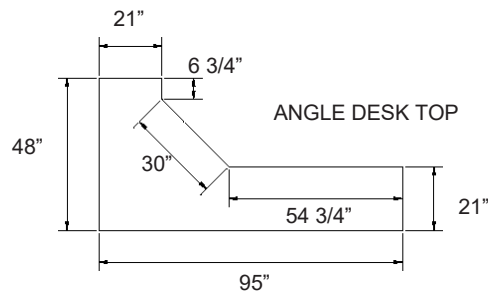
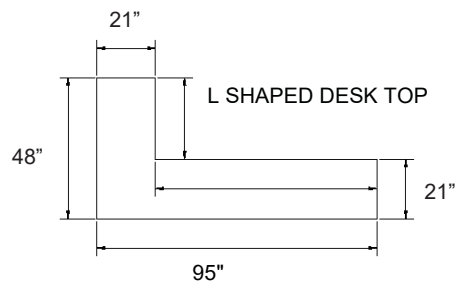

BASE CABINET

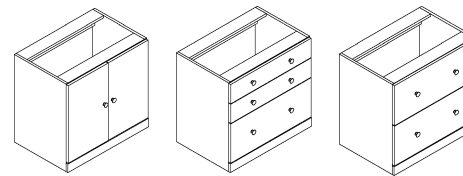

UPPER CABINET 13" Deep

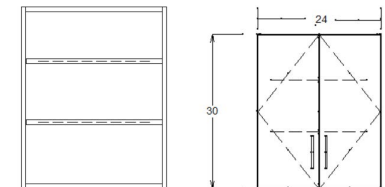

#102 - 12925 115th Avenue
Surrey B.C Canada V3R 0E2
Phone: 604.588.7485

wallbeds.com
info@wallbeds.com
Phone: 604 669 2337

125 - 1080 Mainland Street
Vancouver B.C. Canada V6B 2T4
Phone: 604 669 2337 Fax: 604 685 2337